

# Industriale Series - Domo Acrylic Shade

## SERIES P5A

12" Decorative LED Pendant  
923-10,780



Weight: 8.1 lbs

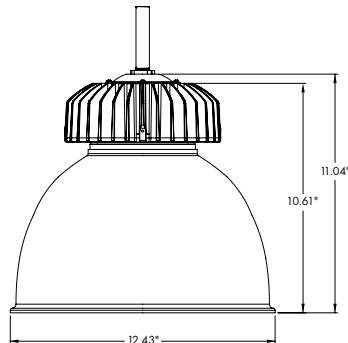
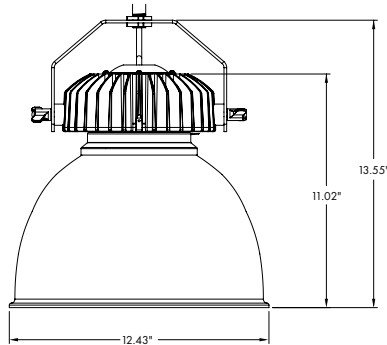

### APPLICATION

Industriale is a family of decorative, suspended LED fixtures that are ideally suited to office, residential, loft, restaurant and retail spaces where long life and energy-efficient LED operation is desirable.

### FEATURES AND BENEFITS

- Vintage industrial look with modern features
- Various mounting options include: bail with modern wing nut, rigid pipe stem, and flexible single aviation cable.
- Available with optional lenses, to enclose the fixture.
- Separate models available for our remote driver platforms of IRD and CentralDrive™ (see below).
- Utilizes an internal dome-shaped cover to spread light rays and obscure the LED engine.
- Custom colors available.

### TECHNICAL DATA

- Max output at 10,000 lumens.
- Input: 120 to 277 VAC, 50-60Hz
- Standard 0-10V 1% dimming, other options listed on page 3.
- CRI = 80. Available in 90 CRI.
- Available with Bridgelux Thrive™ high-fidelity human-centric lighting technology.
- Expected lamp life to be 50,000 hours with 70% lumen maintenance when ambient temperatures do not exceed 35°C. Lower ambient temperatures yield longer lamp life.

### REMOTE DRIVER OPTIONS (PUBLISHED SEPARATELY)

IRD (In-ceiling Remote Driver) features a housing with driver that is recessed in the ceiling and operates a single lighting fixture. Benefits include small 0.25" thick ceiling canopies, emergency (EM) options, and longer driver life due to reduced exposure to the heat of the LED engine. Both new construction and remodel style housings are available.

CentralDrive™ system features a remote panel that operates multiple lighting fixtures. This remote panel can be installed in an easy-to-access area such as a utility closet. Benefits are the same as our IRD system as well as easy driver replacement.

Lighting fixtures for these remote driver systems are published separately and can be found on our website. Please contact our sales team for more information on these options.

[CLICK HERE to view the Industriale Series Brochure](#)



## HOW TO ORDER

### Fixture Body Model Number:

Example: P5YUASASAUAPAV105KDA

Fixture Series	Heat Sink Finish	Bail/Yoke Finish	Bail Knobs	Mounting	Driver
P5 - Basic Industriale	UA = Unfinished Aluminum MW = Matte White MB = Matte Black	N/A	N/A	A* = Cable** Pendant Stem Mount PA = Satin Aluminum Finish^ PW = Matte White Finish^ PB = Matte Black Finish^ PZ = Dark Bronze Finish^	V = Onboard Driver
P5Y - Industriale w/ Adjustable Bail	Custom Colors Available	SA = Satin Aluminum MW = Matte White MB = Matte Black	SA = Satin Aluminum MW = Matte White MB = Matte Black		

Delivered Lumens (Open Shade)	Thrive™	Color Temperature	Dimming	Options
10 = (923-1162, 8W) 20 = (1949-2826, 16W) 30 = (3078-3370, 24W) 40 = (4104-4454, 32W) 50 = (5131-5463, 41W) 60 = (6053-6481, 50W) 70 = (7079-7480, 59W) 80 = (8003-8443, 68W) 90 = (9337-9857, 86W) 100 = (10,260-10,780, 91W) C9 = 90 CRI	T = Thrive High Fidelity Human Centric Technology# 95 CRI. Use scaling factor of 0.54 to determine delivered lumens.	5K = 5000K 4K = 4000K 35K = 3500K 3K = 3000K 27K = 3000K	DA = Xitanium 0-10V 1% linear standard	IEM = EM Battery Pack w/ Integral Test Switch. (Located in ceiling canopy) F = Fuse and Fuse Holder

\* Specify canopy and cord color using "A" followed by number, e.g. "A2"

- |                              |                               |                                |
|------------------------------|-------------------------------|--------------------------------|
| 1 = White canopy/ White cord | 5 = Bronze canopy/ White cord | 9 = White canopy/ Clear cord   |
| 2 = White canopy/ Black cord | 6 = Bronze canopy/ Black cord | 10 = Black canopy/ Clear cord  |
| 3 = Black canopy/ White cord | 7 = Silver canopy/ White cord | 11 = Silver canopy/ Clear cord |
| 4 = Black canopy/ Black cord | 8 = Silver canopy/ Black cord | 12 = Bronze canopy/ Clear cord |

\*\* Cable mounting not available on model with adjustable bail.

^ Finish refers to ceiling canopy color. Stem length and finish are specified separately

# Thrive only available on models with lumen designations 10-80.

### Shade Model Number:

Example: P5ACSA

Shade Style	Color	Transition Ring	Options
P5A = Domo 12" Acrylic Refractor	C = Clear M = Frosted R = Red B = Blue G = Green	SA = Satin Aluminum MW = Matte White MB = Matte Black	1 = Conical Lens 2 = Clear Flat Acrylic Lens 3 = Clear Domed Acrylic Lens



### Stem Kit Specification:

Example: PKU24SA

Pendant Stem	Stem Length	Finish
PKU = Swivel Pendant Kit	Stem Length in Increments of 12" (Add 2" for Canopy)	SA = Satin Aluminum MW = Matte White MB = Matte Black BZ = Bronze

Fixture:	Type:
Project:	

Manufactured and tested to UL#1598/8750 and CSA standards.

All Pathway® products meet or exceed requirements as established by the National Electrical Code. Specifications subject to change without notice.

## DIMMING OPTIONS

Specify option by suffix (shown in bold-face type)

Our White Paper regarding Linear vs. Logarithmic Operating Characteristics is available in our 'Downloads' section of our website, or you may request one by emailing [Sales@PathwayLighting.com](mailto:Sales@PathwayLighting.com)

0-10V Dimming Options	Lutron Dimming Options	DALI Dimming Options
<p>DA = Xitanium 1% 0-10V (linear), Max Lumen = 90                      DB = Xitanium 1% 0-10V (logarithmic), Max Lumen = 90                      DC = EldoLED 0-10V 0% (logarithmic), Max Lumen = 60                      DD = EldoLED 0-10V 1% (logarithmic), Max Lumen = 60                      DE = EldoLED 0-10V 0% (linear), Max Lumen = 60                      DF = EldoLED 0-10V 1% (linear), Max Lumen = 60                      DR = ERP 01-10V 1% (linear) lumen designation 100 only                      DS = 0-10V 1% (linear) 347V only, Max Lumen = 60                      DT = 0-10V 1% (linear) dim-to-off, Max Lumen = 60</p>	<p><b>Maximum Lumen = 40</b></p> <p>DG = Lutron Eco 1% (linear)                      DH = Lutron 3 wire 1% (linear)                      DJ = Lutron 2 wire 1% (linear)</p>	<p><b>Maximum Lumen = 60</b></p> <p>DK = EldoLED DALI 0% (logarithmic)                      DL = EldoLED DALI 1% (logarithmic)</p>
DMX Dimming Options	Misc. Dimming Options	
<p><b>RDM COMPLIANT</b>  <b>MAX LUMEN = 50</b></p> <p>XG = DMX EldoLED 0% (logarithmic)                      XH = DMX EldoLED 0% (linear)</p>	<p>DQ = 2-wire forward/reverse phase (120V) and 0-10V 1% (linear) Max Lumen = 70                      DP = ERP 2-Wire Forward/Reverse Phase (120V, lumen designation 100 only)</p>	
DMX Dimming Options (interfaced through 0-10V driver)		
<p>XA = DMX Xitanium 1% (linear), Max Lumen = 90                      XB = DMX Xitanium 1% (logarithmic), Max Lumen = 90                      XC = DMX EldoLED 0% (logarithmic), Max Lumen = 60                      XD = DMX EldoLED 1% (logarithmic), Max Lumen = 60                      XE = DMX EldoLED 0% (linear), Max Lumen = 60                      XF = DMX EldoLED 1% (linear), Max Lumen = 60                      XR = DMX ERP 1% (linear), lumen designation 100 only</p>		

**DELIVERED LUMENS DATA**

**Data for Clear Refractor fixtures in 3500K color temperature**

FIXTURE	TRIM	LENS	WATTAGE	RATED LUMENS	DELIVERED LUMENS	BEAM DISTRIBUTION	LPW
P5AUNV1035K	P5AC	OPEN	8	1000	1162	29°	145.25
P5AUNV2035K	P5AC	OPEN	16	2000	2826	29°	176.63
P5AUNV3035K	P5AC	OPEN	24	3000	3370	29°	140.42
P5AUNV4035K	P5AC	OPEN	32	4000	4454	29°	139.19
P5AUNV5035K	P5AC	OPEN	41	5000	5463	29°	133.24
P5AUNV6035K	P5AC	OPEN	50	6000	6481	29°	129.62
P5AUNV7035K	P5AC	OPEN	59	7000	7480	29°	126.78
P5AUNV8035K	P5AC	OPEN	68	8000	8443	29°	124.16
P5AUNV9035K	P5AC	OPEN	86	9000	9857	29°	114.62
P5AUNV10035K	P5AC	OPEN	91	10000	10780	29°	118.46
P5AUNV1035K	P5AC1	CONICAL	8	1000	1127	67°	140.89
P5AUNV2035K	P5AC1	CONICAL	16	2000	2741	67°	171.33
P5AUNV3035K	P5AC1	CONICAL	24	3000	3269	67°	136.20
P5AUNV4035K	P5AC1	CONICAL	32	4000	4320	67°	135.01
P5AUNV5035K	P5AC1	CONICAL	41	5000	5299	67°	129.25
P5AUNV6035K	P5AC1	CONICAL	50	6000	6287	67°	125.73
P5AUNV7035K	P5AC1	CONICAL	59	7000	7256	67°	122.98
P5AUNV8035K	P5AC1	CONICAL	68	8000	8190	67°	120.44
P5AUNV9035K	P5AC1	CONICAL	86	9000	9561	67°	111.18
P5AUNV10035K	P5AC1	CONICAL	91	10000	10457	67°	114.91

Above values reflect 3500K color temperatures  
 Scaling factors for other color temperatures: 2700K=0.92; 3000K=0.97; 4000K=1.01; 5000K=1.04  
 Scaling Factor for 90 CRI=0.83  
 Scaling Factor for Thrive = 0.54

**DELIVERED LUMENS DATA**

**Data for Frosted Refractor fixtures in 3500K color temperature**

FIXTURE	TRIM	LENS	WATTAGE	RATED LUMENS	DELIVERED LUMENS	BEAM DISTRIBUTION	LPW
P5AUNV1035K	P5AM	OPEN	8	1000	923	65°	115.43
P5AUNV2035K	P5AM	OPEN	16	2000	1949	65°	121.84
P5AUNV3035K	P5AM	OPEN	24	3000	3078	65°	128.25
P5AUNV4035K	P5AM	OPEN	32	4000	4104	65°	128.25
P5AUNV5035K	P5AM	OPEN	41	5000	5130	65°	125.12
P5AUNV6035K	P5AM	OPEN	50	6000	6053	65°	121.07
P5AUNV7035K	P5AM	OPEN	59	7000	7079	65°	119.99
P5AUNV8035K	P5AM	OPEN	68	8000	8003	65°	117.69
P5AUNV9035K	P5AM	OPEN	86	9000	9337	65°	108.57
P5AUNV10035K	P5AM	OPEN	91	10000	10260	65°	112.75
P5AUNV1035K	P5AM1	CONICAL	8	1000	895	67°	111.91
P5AUNV2035K	P5AM1	CONICAL	16	2000	1891	67°	118.16
P5AUNV3035K	P5AM1	CONICAL	24	3000	2986	67°	124.40
P5AUNV4035K	P5AM1	CONICAL	32	4000	3978	67°	124.31
P5AUNV5035K	P5AM1	CONICAL	41	5000	4976	67°	121.37
P5AUNV6035K	P5AM1	CONICAL	50	6000	5871	67°	117.43
P5AUNV7035K	P5AM1	CONICAL	59	7000	6867	67°	116.38
P5AUNV8035K	P5AM1	CONICAL	68	8000	7763	67°	114.16
P5AUNV9035K	P5AM1	CONICAL	86	9000	9057	67°	105.31
P5AUNV10035K	P5AM1	CONICAL	91	10000	9952	67°	109.36

Above values reflect 3500K color temperatures  
 Scaling factors for other color temperatures: 2700K=0.92; 3000K=0.97; 4000K=1.01; 5000K=1.04  
 Scaling Factor for 90 CRI=0.83  
 Scaling Factor for Thrive = 0.54

**MOUNTING CONFIGURATIONS**

**MOUNTING:** (Specify when ordering.)

Pendant Mount – Swivel mount canopy allows cylinder to hang plumb up to 45° sloped ceiling stem 3/8" IPS (specify length in increments of 12") canopy adds 2.0" to overall length. Standard finish white powder coat.

Adjustable bail option may cause the fixture not to hang plumb when over adjusted. Locking collar (LC) is provided to lock swivel stem is an available option.

Specify Pendant Kit as follows:

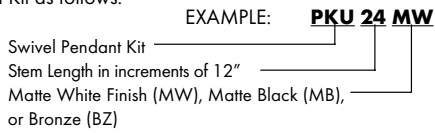

Aviation Cable Mount – Supplied with 10' field adjustable aviation cable and straight cord.

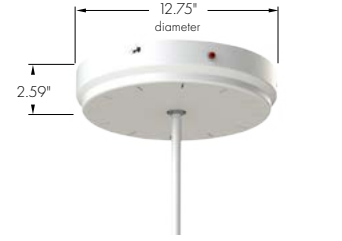
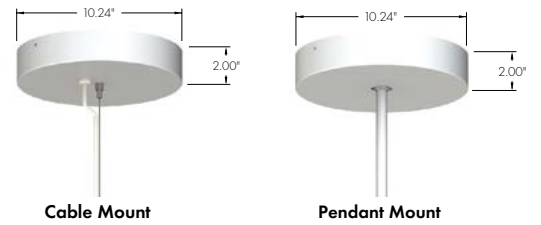

**Larger Ceiling Canopy Provided for Model with Emergency IEM Option**

**COLOR CHART**

**Standard Finishes (Powder Coat)**



Matte Black (MB)



Bronze (BZ)

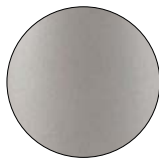

Satin Aluminum (SA)

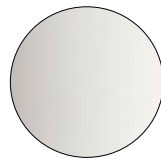

Matte White (MW)

**Special Finishes Available. Contact our sales department.**

