

SERIES P48FL2X/PR12W/AP16

Decorative LED Pendant
732-4631 Lumens



APPLICATION

Suspended LED downlights for general illumination in medium to high ceiling applications such as offices, malls and retail spaces where long life and energy efficient LED operation is desirable.

FEATURES AND BENEFITS

- Heavy-gauge aluminum reflector with satin anodized finish, with white painted interior for uniform light distribution.
- The cylindrical housing is constructed of satin anodized aluminum extrusions, finned for optimum heat dissipation.
- Chrome plated steel decorative rods support decorative elements while projecting a rugged industrial appearance of the fixture.
- Mounting options include: Pendant Stem, Wall, Surface, and Straight Cord.
- Custom colors available.

TECHNICAL DATA

- Input: 120 to 277 VAC, 50-60 Hz, 347V optional.
- 0-10V 1% (linear) dimming. Other options available.
- CRI = 80. Available in 90 CRI.
- Expected lamp life to be 50,000 hours with 70% lumen maintenance when ambient temperatures do not exceed 35°C. Lower ambient temperatures yield longer lamp life.

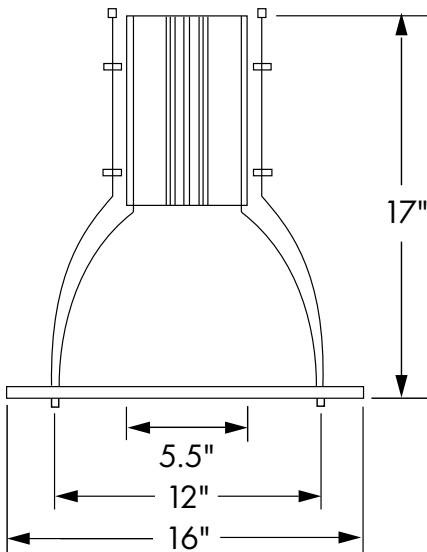

HOW TO ORDER

Catalog #:

Example: P48FL2X303KDAS1A / PR12AW / AP16

Fixture Series	Delivered Lumens	Color Temp.	Dimming	Suspension	Ceiling Canopy / Cord Color
P48FL2X	8 = 732L, 7W 11 = 1046L, 10W 15 = 1382L, 14W 20 = 1868L, 20W 30 = 2577L, 29W 40 = 3735L, 40W 50 = 4631L, 50W C9 = 90 CRI See third page for delivered lumens data and 90 CRI wattages.	5K ¹ = 5000K 4K = 4000K 35K = 3500K 3K = 3000K 27K ² = 2700K	DA = Xitanium 1% 0-10V (linear) standard More Options On Next Page	S = Aviation Cable/ straight 10' cord For special length, specify in feet (ie, S16 = 16') P = Pendant provision F = Surface Mount W1 = Straight Wall Bracket PH = Power Hook	(for S mounting) 1 = White canopy/ White cord 2 = White canopy/ Black cord 3 = Black canopy/ White cord 4 = Black canopy/ Black cord 5 = Bronze canopy/ White cord 6 = Bronze canopy/ Black cord 7 = Silver canopy/ White cord 8 = Silver canopy/ Black cord 9 = White canopy/ Clear cord 10 = Black canopy/ Clear cord 11 = Silver canopy/ Clear cord 12 = Bronze canopy/ Clear cord

Upper Housing Finish	Options
A = Anodized Aluminum W = White B = Black Z = Bronze	F = Fuse IEM = EM Battery Pack w/ Integral Test Switch. Special ceiling canopy required. Not available in wall mount

¹ 5000K only available in 80 CRI
² 2700K only available in 90 CRI (C9).

Shade Style	Exterior Lower Shade	Interior Lower Shade	Decor Attachment
PR12 = Acrylic Refractor	A = Anodized Aluminum W = White B = Black Z = Bronze	W = White	AP16 = Acrylic Disc FG16 = Soda Lime Glass Disc CB16 = Cobalt Glass Disc

Stem Kit Specification:

Example: PK24W

Pendant Stem	Stem Length	Finish
PK = Swivel Pendant Kit	Stem Length in increments of 12 Inches (Add 2" for Canopy)	SA = Satin Aluminum W = White B = Black Z = Bronze

Fixture:	Type:
Project:	

Manufactured and tested to UL#1598/8750 and CSA standards.
 All Pathway® products meet or exceed requirements as established by the National Electrical Code. Specifications subject to change without notice.

DIMMING OPTIONS

Dimming Options:

Specify option by suffix (shown in bold-face type)

Our White Paper regarding Linear vs. Logarithmic Operating Characteristics is available in our 'Downloads' section of our website, or you may request one my emailing Sales@PathwayLighting.com

0-10V Dimming Options	Lutron Dimming Options	DALI Dimming Options	Forward/Reverse Phase Options
<p>DA = Xitanium 1% 0-10V (linear) DB = Xitanium 1% 0-10V (logarithmic) DC = EldoLED 0-10V 0% (logarithmic) DD = EldoLED 0-10V 1% (logarithmic) DE = EldoLED 0-10V 0% (linear) DF = EldoLED 0-10V 1% (linear)</p> <p>Max Lumen = 5000 at 80 CRI, or Max Lumen = 4000 at 90 CRI DS = 0-10V 1% (linear) 347V only¹ DT = 0-10V 1% (linear) dim to off</p>	<p>Contact Factory</p>	<p>Max Lumen = 5000 at 80 CRI, or Max Lumen = 4000 at 90 CRI DK = EldoLED DALI 0% (logarithmic) DL = EldoLED DALI 1% (logarithmic)</p>	<p>DM = 120V 2-wire forward/reverse phase 1% (linear)</p>

DMX [^] Dimming Options (interfaced through 0-10V driver)	RDM DMX
<p>XA = DMX Xitanium 1% (linear)¹ XB = DMX Xitanium 1% (logarithmic)¹ XC = DMX EldoLED 0% (logarithmic)¹ XD = DMX EldoLED 1% (logarithmic)¹ XE = DMX EldoLED 0% (linear)¹ XF = DMX EldoLED 1% (linear)¹</p>	<p>Max Lumen = 4000 at 80 CRI, or Max Lumen = 3000 at 90 CRI XG = DMX EldoLED 0% (logarithmic) XH = DMX EldoLED 0% (linear)</p>

¹ DMX and 347V input (E3) options are not compatible with emergency battery options.

DELIVERED LUMENS

Delivered Lumen Data - 80 CRI (3500K Color Temperature)

FIXTURE	TRIM	LENS	RATED LUMENS	WATTAGE	DELIVERED LUMENS	BEAM DISTRIBUTION	LPW
P48FL2X835KDA,DB	PS 12WAW_AP16	ACRYLIC DISC	800	7	732	61°	104.6
P48FL2X1135KDA,DB	PS 12WAW_AP16	ACRYLIC DISC	1100	10	1046	61°	104.6
P48FL2X1535KDA,DB	PS 12WAW_AP16	ACRYLIC DISC	1500	14	1382	61°	98.7
P48FL2X2035KDA,DB	PS 12WAW_AP16	ACRYLIC DISC	2000	20	1868	61°	93.4
P48FL2X3035KDA,DB	PS 12WAW_AP16	ACRYLIC DISC	3000	29	2577	61°	88.9
P48FL2X4035KDA,DB	PS 12WAW_AP16	ACRYLIC DISC	4000	40	3735	61°	93.4
P48FL2X5035KDA,DB	PS 12WAW_AP16	ACRYLIC DISC	5000	50	4631	61°	92.6



Above Values reflect 3500K color temperatures and DA or DB Dimming. Add 2 Watts to power for other dimming options.
Scaling factors for other color temperatures: 3000K = 0.97 ; 4000K = 1.03 ; 5000K = 0.98

Delivered Lumen Data - 90 CRI (3500K Color Temperature)

FIXTURE	TRIM	LENS	RATED LUMENS	WATTAGE	DELIVERED LUMENS	BEAM DISTRIBUTION	LPW
P48FL2X835C9KDA,DB	PS 12WAW_AP16	ACRYLIC DISC	800	9	783	61°	87.1
P48FL2X1135C9KDA,DB	PS 12WAW_AP16	ACRYLIC DISC	1100	12	1046	61°	87.2
P48FL2X1535C9KDA,DB	PS 12WAW_AP16	ACRYLIC DISC	1500	17	1375	61°	80.9
P48FL2X2035C9KDA,DB	PS 12WAW_AP16	ACRYLIC DISC	2000	24	1842	61°	76.7
P48FL2X3035C9KDA,DB	PS 12WAW_AP16	ACRYLIC DISC	3000	36	2801	61°	77.8
P48FL2X4035C9KDA,DB	PS 12WAW_AP16	ACRYLIC DISC	4000	48	3761	61°	78.4
P48FL2X5035C9KDA,DB	PS 12WAW_AP16	ACRYLIC DISC	5000	62	4655	61°	75.1

Above Values reflect 3500K color temperatures and DA or DB Dimming. Add 2 Watts to power for other dimming options.
Scaling factors for other color temperatures: 2700K = 0.93 ; 3000K = 0.97 ; 4000K = 1.03

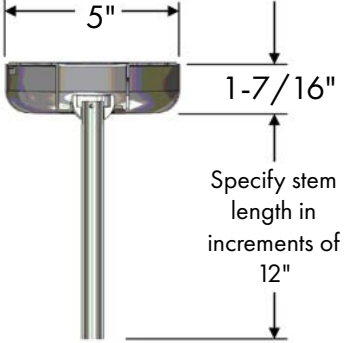
MOUNTING CONFIGURATIONS

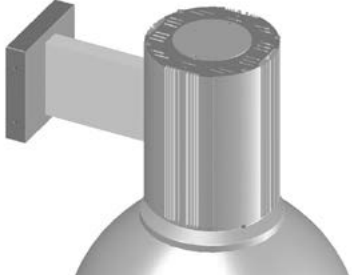
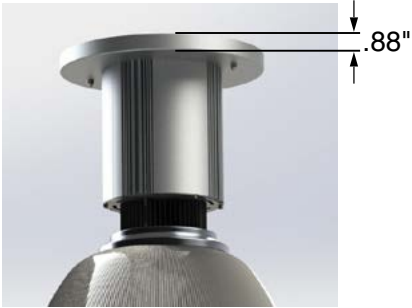
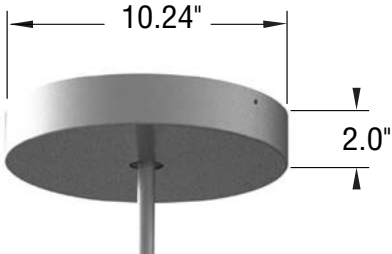
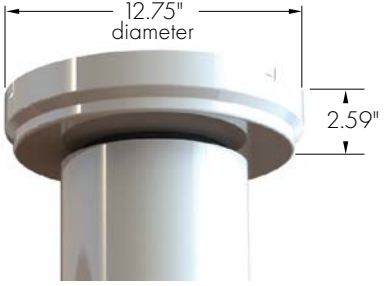
Pendant Mount	Straight Cord	Wall Mount
 <p>5"</p> <p>1-7/16"</p> <p>Specify stem length in increments of 12"</p>	 <p>Supplied with 10' field adjustable aviation cable and either straight or coiled cord. Ceiling canopy to match finish on cylinder housing. Custom lengths available.</p>	 <p>Standard bracket extends 10" from wall. Mounts to 4" octagon junction box. DMX wall bracket extends 11.97".</p>
Surface Mount	Universal Ceiling Canopy	Emergency Ceiling Canopy
 <p>.88"</p> <p>Provided with mounting holes for securement to 4" octagon junction box. Canopy adds .88" to overall height</p>	 <p>10.24"</p> <p>2.0"</p> <p>For DMX option. Available for surface, pendant stem and straight cord mounting styles.</p>	 <p>12.75" diameter</p> <p>2.59"</p> <p>Available for surface, pendant stem and straight cord mounting styles and emergency options (IEM). Not available on wall mount models.</p>

COLOR CHART

Standard Finishes (Powder Coat)



Matte Black (MB)



Bronze (BZ)



Satin Aluminum (SA)

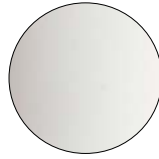

Matte White (Blank)

Special Finishes Available. Contact our sales department.

